

**HYCONTROL**



*Level Measurement*

*With*

**REFLEX RADAR**

# Why Radar Technology for Level Measurement ?

## INSENSITIVE TO CHANGES IN

- ◆ Dielectric
- ◆ Pressure
- ◆ Vacuum
- ◆ Humidity
- ◆ Dust
- ◆ Viscosity
- ◆ Foam
- ◆ Temperature

## THE ADVANTAGES ARE

- ◆ Measuring ranges up to 40m (option for 100m special).
- ◆ Versatile technology for Liquids, Slurries, Pastes and Solids.
- ◆ Display of Level, Distance or Volume.
- ◆ Interface detection on liquids.
- ◆ 2 wire loop powered 24vdc or 4 wire 110/230vac.
- ◆ Hazardous area ATEX, EExd and EExia.
- ◆ HART, Profibus (PA) and Foundation Fieldbus.
- ◆ Suitable for narrow tanks with minimum fixed beam diameter.
- ◆ Unaffected by dust during fill or empty conditions.
- ◆ Immune to fill noise on solid products such as stone.
- ◆ Simple to install and retrofit with wide range of process connections.
- ◆ Suitable for corrosive and acidic atmospheres.
- ◆ High temperature and pressure options are available.
- ◆ Remote or local programming and commissioning.
- ◆ Suitable for detecting levels through surface foam.
- ◆ Sealed Flange system allows removal in process

## SUITABLE FOR ALL INDUSTRIES

- ◆ Petrochemical
- ◆ Food
- ◆ Chemical
- ◆ Paint
- ◆ Water & Waste
- ◆ Cement
- ◆ Asphalt
- ◆ Minerals
- ◆ Power Generation
- ◆ Steel
- ◆ Quarrying
- ◆ Powder

## RADAR FOR A VARIETY OF APPLICATIONS

- ◆ Level Measurement
- ◆ Distance Measurement
- ◆ Interface Measurement
- ◆ Volume Measurement

## COST EFFECTIVE REPLACEMENT FOR

- ◆ Capacitance transmitters
- ◆ Hydrostatic transmitters
- ◆ Differential pressure transmitters
- ◆ Displacers

## MANUFACTURED TO ISO9001-2000 Q.M.S.



Various units on final assembly and ready for test. The quality of all Hycontrol products is strictly monitored to conform to the ISO certification requirements.

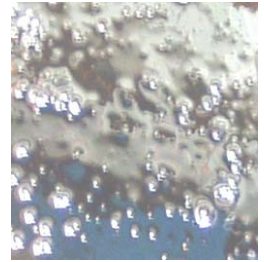

Acids



Plastics



Grain



Powders



Flakes

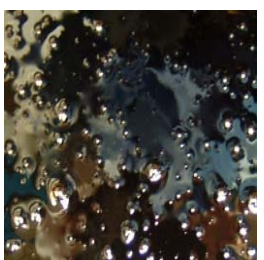

Oils

# Reflex VF Series Two Wire TDR

The Reflex VF Series range of TDR products is ideal for the measurement of liquids, powders and granules to a range of 35m. Unaffected by pressure, temperature, viscosity, vacuum, foam, dust, changes in dielectric constant or coating of the probe, the VF Series can measure virtually any product in either Direct or TBF mode utilising any one of its six probe types. (See page 4 for full option details).

## ADVANTAGES OF TDR

- ◆ 35m Measuring Range
- ◆ 24 VDC 2 wire Loop Powered
- ◆ 4/20mA Output
- ◆ Pressure up to 40 Bar
- ◆ Flange temperature up to 200°C
- ◆ HART Protocol options
- ◆ ATEX EExia and EExd options
- ◆ Wide range of Process connections
- ◆ Liquids and Solids measurement
- ◆ Interface measurement to less than 50mm
- ◆ Simple programming with set-up wizard
- ◆ Capable of measuring low dielectric product (1.4)
- ◆ Clear Alpha-numeric display with tank illustrations
- ◆ Minimal Blanking Zone
- ◆ High accuracy of  $\pm 3\text{mm}$
- ◆ Corrosion resistant construction



## OPERATING PRINCIPLE

Pulses of low power microwaves are sent along conductors. At the point where the waves meet the product surface, they are reflected by the product. The intensity of the reflection depends on the dielectric constant of the product. The higher the dielectric constant, the stronger the reflection will be, e.g. Up to 80% reflection for water. The instrument measures the time between emission and reception which is proportional to the distance.

For TDR guided radar there are two different categories of product:

### 1 - Products with a dielectric constant $\epsilon_r \geq 1.4$

These applications work in "Direct Mode", which means that the reflection from the product surface is used directly for the measurement of the level. Two different applications are possible:

#### a) Level Measurement

The wave is reflected from the first product surface and is received by the receiver on the top of the tank. The wave travels along the conductor above the product at the speed of light and the return time of the wave pulse is directly proportional to the distance between the top of the tank and the surface of the product (level).

#### b) Interface measurement

Interface measurement can only be made if the first layer has a lower dielectric constant than the second and if the difference between the two dielectric constants is greater than 10.

For measuring interface level we use the residual wave after the first reflection. This part of the wave moves further down the conductors through the first product layer until reflected on the interface level. The speed of this wave depends on the dielectric constant of the first product. This means that we have to know the dielectric ( $\epsilon_r$ ) of this first layer to determine the interface level.

### 2 - Products with a dielectric constant $\epsilon_r < 1.4$

To measure the level of low dielectric products we use the Tank Bottom Following principle (TBF). The downward wave will first pass through the air at a known speed and then through the product at a speed depending on the dielectric constant of the product.

Since the return in air is calibrated; the difference in the two times is directly proportional to the product level in the tank.

As we are largely dependent on the dielectric constant, this method is less accurate than the direct mode method.

# TDR Product Selector

Model	VF7000	VF7001	VF7002	VF7003	VF7004	VF7005
Probe type	F	A	D	H	K	B
Principle	TDR	TDR	TDR	TDR	TDR	TDR
Process	Liquids	Liquids	Liquids	Liquids	Liquids	Liquids
Medium	Solids	Solids		Solids*	Solids	Solids
Range	3m	3m	6m	35m	35m	35m
Application	Level	Level	Level	Level	Level	Level
	Distance	Distance	Distance	Distance	Distance	Distance
	Volume	Volume	Volume	Volume	Volume	Volume
	Interface	Interface	Interface	Interface	Interface	Interface
Mode	Direct TBF	Direct TBF	Direct TBF	Direct TBF	Direct TBF	Direct TBF
<b>Accuracy</b>						
Liquids	+/-3mm	+/-3mm	+/-3mm	+/-3mm	+/-3mm	+/-3mm
Solids	+/-20mm	+/-20mm		+/-20mm	+/-20mm	+/-20mm
Min Dielectric	1.8	1.6	1.4	1.8	1.8	1.6
Repeatability	+/- 1mm	+/- 1mm	+/- 1mm	+/- 1mm	+/- 1mm	+/- 1mm
Max Press. Bar	40	40	40	40	40	40
Max Temp. °C	200	200	200	200	200	200
<b>Power Supply</b>						
24 VDC	Yes	Yes	Yes	Yes	Yes	Yes
Two Wire	Yes	Yes	Yes	Yes	Yes	Yes
Four Wire	No	No	No	No	No	No
4/20 HART	Yes	Yes	Yes	Yes	Yes	Yes
RS485	No	Yes	No	No	No	Yes
Profibus PA		Yes	No	No	No	Yes
Fieldbus		Yes	No	No	No	Yes
<b>Approvals</b>						
ATEX EExia	Yes	Yes	Yes	Yes	Yes	Yes
ATEX EExd	Yes	Yes	Yes	Yes	Yes	Yes
Integral LCD	Optional	Optional	Optional	Optional	Optional	Optional
Min Process Con	3/4" BSP	2"ANSI	3/4" BSP	3/4" BSP	1.5" BSP	2"ANSI

**\*Note:**

Hycontrol advise the use of 8mm cable for Solids applications due to the high loads and abrasive wear usually associated with these applications. However, for short cable length and light powders such as flour, 4mm may be acceptable, up to 10m.

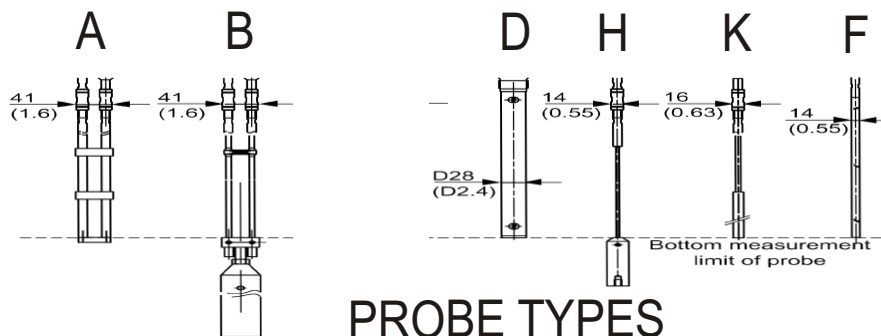

# Reflex VG5XX 10GHz FMCW Radar

## THE ADVANTAGES OF FMCW RADAR

- ◆ Non-contact
- ◆ Aggressive liquids, hydrocarbons, toxic liquids and slurries
- ◆ Granulated material and most solids
- ◆ Range up to 40 metres (option for 100 metres)
- ◆ Unaffected by pressure, temperature, viscosity, foam or dust
- ◆ Available with Horn Wave Guide or Wave Stick antenna
- ◆ ATEX EExia intrinsically safe or EExd flameproof housings
- ◆ TBF mode available for low dielectric products
- ◆ ETS mode damps out unwanted reflection
- ◆ 1mm accuracy option

## OPERATING PRINCIPLE

A radar signal is generated via an antenna, reflected by the target surface and received after a delay time  $t$ .

### FMCW: Frequency Modulated Continuous Wave

FMCW radar uses a high frequency signal (~10GHz) which increases linearly by 1GHz during the measurement (frequency sweep) (1). The signal is emitted, reflected from the target surface and received at a time-delayed (2) frequency.

The difference,  $\Delta f$ , is calculated from the actual transmit frequency and the receive frequency (3). The difference is directly proportional to the distance measured i.e. a large frequency difference corresponds to a large distance, and vice versa.

The frequency difference is transformed via a Fast Fourier Transformation (FFT) into a lower frequency spectrum and then the distance is calculated from this spectrum. The level results from the difference between the tank height and distance.

### Linearity of frequency sweeps

The measuring accuracy of FMCW radar is determined from the linearity of the frequency sweeps and their reproducibility. The linearity correction is deduced via reference measurement of the oscillator. The non-linearity is corrected up to 98% (VG50/51/VG500). An immediate frequency regulation using PLL (phase locked loop) technology is necessary with the VG502 device because of the higher demand on the measuring accuracy.

### Advantages of FMCW principle compared to Pulse Radar:

- ◆ Better reflection separation
- ◆ Reliable noise reduction
- ◆ Smaller beam angle
- ◆ Fewer disturbing reflections
- ◆ Smaller antenna diameter for same measuring range

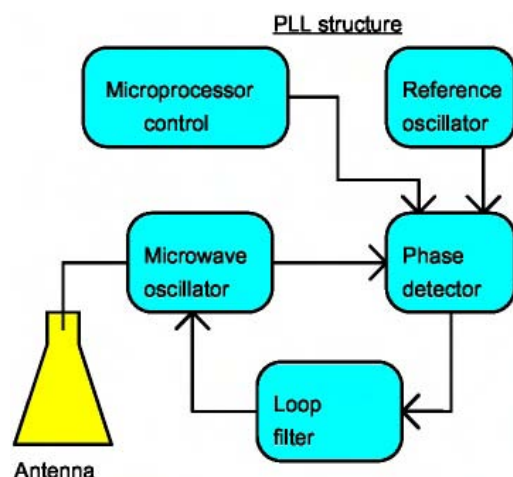
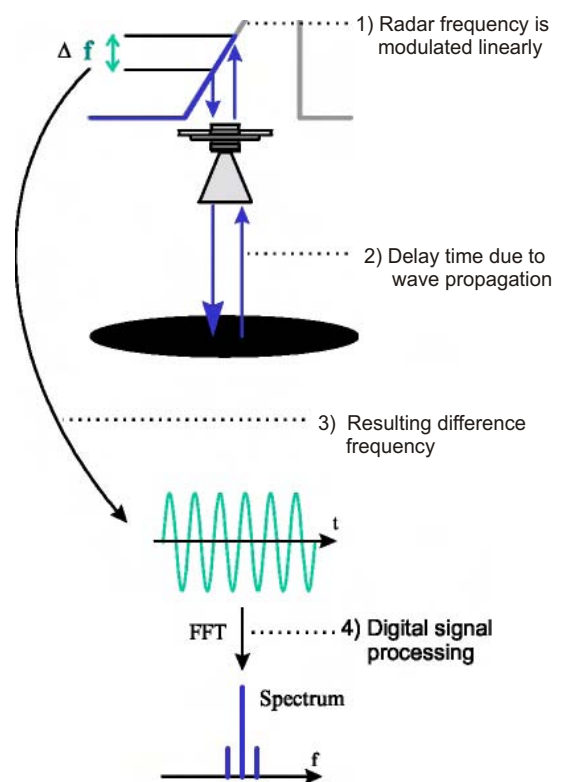

# Reflex VG7 26GHz FMCW Radar

## ADVANTAGES OF VG7 SERIES

- ◆ Non-contact level measurement
- ◆ Aggressive liquids, hydrocarbons, toxic liquids, slurries
- ◆ Granulated material and most solids
- ◆ Measuring range up to 40 metres
- ◆ Unaffected by pressure, temperature, viscosity, foam or dust
- ◆ ATEX EExia intrinsically safe or EExd flameproof approvals
- ◆ TBF mode available for low dielectric products
- ◆ ETS mode damps out unwanted reflection
- ◆ High accuracy of  $\pm 3\text{mm}$  as standard
- ◆ Low dielectric products measured (1.4)
- ◆ Simple and easy programming with set-up wizard
- ◆ Small Blanking Zone
- ◆ Wide range of mounting flange and thread options
- ◆ Corrosion resistant construction

## OPERATING PRINCIPLE

The VG7 High frequency FMCW Radar operates on exactly the same proven principle of the lower frequency 10GHz FMCW Radar. The main technical advantages of the Reflex VG7 are:

- ◆ **High average transmit frequency of 25 GHz.**
- ◆ **Larger bandwidth of 2 GHz.**
- ◆ **Dynamic range of more than 100 dB.**
- ◆ **Highly stable, fully crystal-controlled transmit frequency.**

In addition to the above, a digital signal processor provides the system with a very high computing capacity and complex evaluation algorithms ensure reliable and precise calculation of measured values.

Given the same size of antenna, and compared to lower frequencies, 10 GHz for the VG5xx, the high average transmit frequency of 25 GHz allows better concentration of the microwave signals. This allows better focusing of the target and improves accuracy of the measured value, stability of the measurement, and increases insensitivity to tank internals.

The 2 GHz bandwidth is one of the most important factors for accurate and stable measurements. A large bandwidth makes it easier to distinguish between unwanted and wanted signals, and the measured values can be evaluated with greater accuracy.

Another very important factor is the dynamic range of more than 100 dB that is attained when using the FMCW principle. The dynamic range determines the ratio between the strongest signals that the system can sense and the weakest possible signals in the form of fundamental noise.

# Reflex VG Series Two & Four Wire FMCW Radar

The Reflex VG Series of FMCW Radar products are unaffected by pressure, temperature, viscosity, vacuum, foam, dust or changes in dielectric constant. They can measure virtually any product in either Direct or TBF mode utilising either Horn, Wave Guide or Wave Stick antenna.

The unique Tank Bottom Following (TBF) mode in all the VG Series enables products with dielectric constants as low as 1.1 to be measured. For process vessels with complex internal structures the unique Empty Tank Spectrum (ETS) can be utilised to damp out all unwanted reflections from pipes, heating coils and agitators.

## TWO WIRE FMCW RADAR

### VG50 HORN - Range 20m

- ◆ EExia two wire
- ◆ HART
- ◆ Steam
- ◆ Foam
- ◆ Agitation
- ◆ Temperature up to 250°C
- ◆ Pressure up to 64 Bar
- ◆ Viscous liquids
- ◆ Dielectric greater than 2

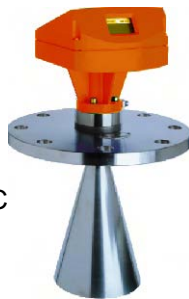

### VG51 WAVE STICK - Range 20m

- ◆ EExia two wire
- ◆ HART
- ◆ Small nozzle
- ◆ Corrosive liquids
- ◆ Clean liquids
- ◆ Temperature up to 150°C
- ◆ Pressure up to 16 Bar
- ◆ Dielectric greater than 4



## FOUR WIRE FMCW RADAR

### VG500 HORN - Range 40m (option 100m)

- ◆ Liquids & Solids
- ◆ EExd four wire
- ◆ HART & Profibus
- ◆ Foundation Fieldbus
- ◆ Steam & Foam
- ◆ Agitation
- ◆ Temperature up to 250°C
- ◆ Pressure up to 64 Bar
- ◆ Viscose liquids
- ◆ Dielectric greater than 2



### VG510 WAVE STICK - Range 20m

- ◆ EExd four wire
- ◆ HART
- ◆ Profibus
- ◆ Foundation Fieldbus
- ◆ Small Nozzle
- ◆ Corrosive Liquids
- ◆ Clean Liquids
- ◆ Temperature up to 150°C
- ◆ Pressure up to 16 Bar
- ◆ Dielectric greater than 4



## HIGH ACCURACY FMCW

### VG502 HORN - 1mm accuracy

- ◆ Liquids
- ◆ EExd four wire
- ◆ HART
- ◆ Profibus
- ◆ Foundation Fieldbus
- ◆ Temperature up to 250°C
- ◆ Pressure up to 64 Bar
- ◆ Viscous liquids
- ◆ Dielectric greater than 2
- ◆ 1mm Accuracy



### REFLEX VG7 HORN - 3mm accuracy

- ◆ Liquids and Solids
- ◆ EExia and EExd four wire
- ◆ 4-20mA Output
- ◆ Pressure to 40 bar
- ◆ Flange temperature 200°C
- ◆ HART Protocol
- ◆ Viscous liquids
- ◆ Dielectrics greater than 2
- ◆ Antenna DN40 - DN80
- ◆ 3mm Accuracy



# FMCW Product Selector

Model	VG50	VG50	VG51	VG500	VG500	VG502	VG502	VG510	VG7
Antenna Type	Horn	Waveguide	Wavestick	Horn	Waveguide	Horn	Waveguide	Wavestick	Horn
Principle	FMCW	FMCW	FMCW	FMCW	FMCW	FMCW	FMCW	FMCW	FMCW
Process	Liquids	Liquids	Liquids	Liquids	Liquids	Liquids	Liquids	Liquids	Liquids
Medium				Solids					Solids
Range	20m	6m	20m	40m	6m	35m	6m	20m	40m
Application	Level	Level	Level	Level	Level	Level	Level	Level	Level
	Distance	Distance	Distance	Distance	Distance	Distance	Distance	Distance	Distance
	Volume	Volume	Volume	Volume	Volume	Volume	Volume	Volume	Volume
Mode	Direct.TBF	Direct.TBF	Direct.TBF	Direct.TBF	Direct.TBF	Direct.TBF	Direct.TBF	Direct.TBF	Direct.TBF
<b>Accuracy</b>									
Liquids	+/- 0.3%	+/- 0.3%	+/- 0.3%	+/- 0.3%	+/- 0.3%	+/- 1mm	+/- 1mm	+/- 0.3%	+/- 3mm
Solids	No	No	No	*	No	No	No	No	Yes
Min Dielectric	2	1.5	4	2	1.5	2	1.5	4	2
Repeatability	+/- 1mm	+/- 1mm	+/- 1mm	+/- 1mm	+/- 1mm	+/- 1mm	+/- 1mm	+/- 1mm	+/- 1mm
Max Press. Bar	64	64	16	64	64	64	64	16	40
Max Temp. °C	250	250	150	250	250	250	250	150	200
<b>Power Supply</b>									
24 VDC	Yes	Yes	Yes	No	No	No	No	No	Yes
24 VAC/DC	No	No	No	Yes	Yes	Yes	Yes	Yes	No
110/230 AC	No	No	No	Yes	Yes	Yes	Yes	Yes	No
Two Wire	Yes	Yes	Yes	No	No	No	No	No	Yes
Four Wire	No	No	No	Yes	Yes	Yes	Yes	Yes	No
4/20 HART	Yes	Yes	Yes	Yes	Yes	Yes	Yes	Yes	Yes
RS485	No	No	No	Yes	Yes	Yes	Yes	Yes	No
Profibus PA	No	No	No	Yes	Yes	Yes	Yes	Yes	Option
Fieldbus	No	No	No	Yes	Yes	Yes	Yes	Yes	Option
ATEX Approval	EExia	EExia	EExia	EExde	EExde	EExde	EExde	EExde	EExia/EExde
Integral LCD	Yes	Yes	Yes	Yes	Yes	Yes	Yes	Yes	Yes
Min Process Con	3" ANSI	3" ANSI	1.5" BSP	3" ANSI	3" ANSI	8" ANSI	3" ANSI	1.5" BSP	1.5" BSP

\*Consult Hycontrol

## FLEXIBILITY BY MODULAR DESIGN

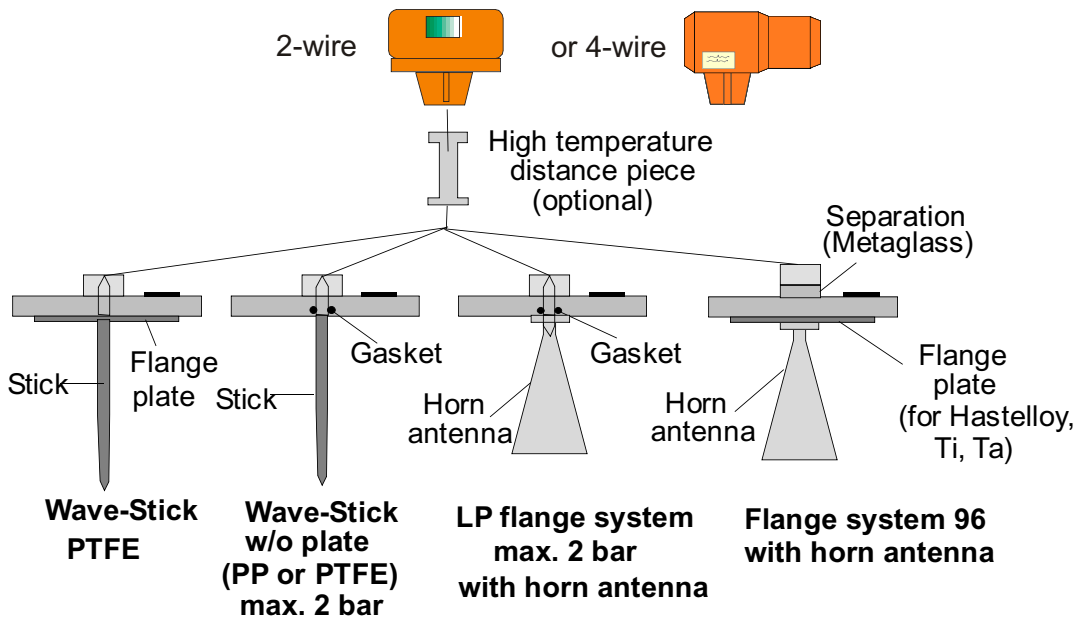

**COMPLETELY SEALED FLANGE SYSTEM ALLOWS REMOVAL OF ELECTRONIC HEADS IN SERVICE.**



# Applications



**VG500. Iron Ore. 15m. Steel**



**VF7. Bentonite. 11m. Steel**



**VG50 Crude Oil. 18m. Petrochemical**



**VF7. Salt. 8m. Food**



**VG7. Wood Chips. 12m. Furniture**



**VG7. Chemical Waste. 5m. Chemical**

# HYCONTROL LEVEL TECHNOLOGIES

Level product range includes :-

- (1) TDR Radar for solids
- (2) Ultrasonic, 'through air'
- (3) Continuous 'servo' level indicator
- (4) Capacitance level switch
- (5) Vibrating probe level switch
- (6) Rotating paddle level switch
- (7) By-pass level indicator with radar
- (8) TDR Radar for liquids
- (9) 2 wire Ultrasonic transmitter
- (10) FMCW 2 wire 'wavestick' Radar
- (11) Magnetic Float switches
- (12) FMCW 'Horn' Radar 2 wire
- (13) Capacitance level switch
- (14) Side mounting 316 SS float switch
- (15) Vibrating fork level switch
- (16) Ultrasonics 'through wall'
- (17) Mini magnetic float level switch
- (18) RF Admittance level switch

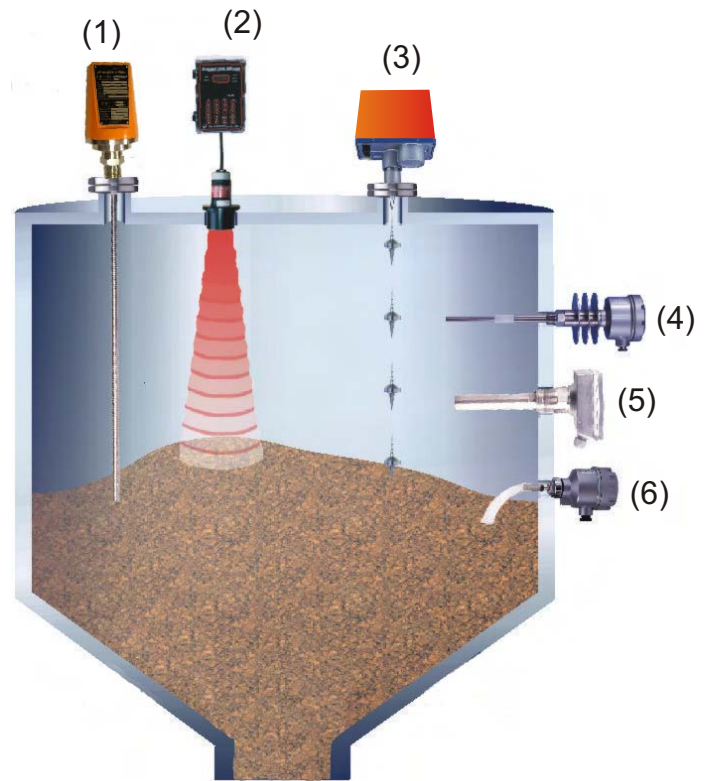

## SOLIDS

**IF YOU ARE UNSURE WHICH TECHNOLOGY TO USE FOR YOUR APPLICATION PLEASE CONSULT HYCONTROL INSTRUMENT ENGINEERS FOR APPLICATION ADVICE OR A FREE SITE LEVEL SURVEY.**

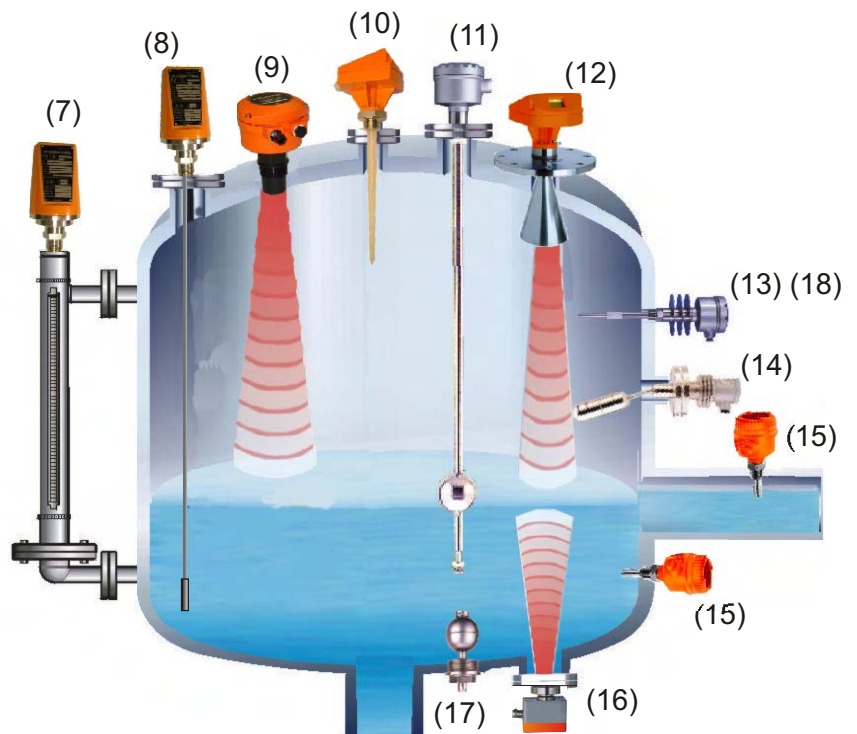

## LIQUIDS

### HYCONTROL LTD

Larchwood House  
Orchard Street  
Redditch  
Worcestershire  
England  
B98 7DP

Tel : 01527 406800  
Fax : 01527 406810

Email : [sales@hycontrol.com](mailto:sales@hycontrol.com)  
Website : [www.hycontrol.com](http://www.hycontrol.com)

**Technical Data Sheet - Type VF7**
**Input**

Function		Time Domain Reflectometry (TDR )
Parameter		Level, distance, volume and/or interface
Max. measuring range	Double rod Ø8 mm / 0.3"	4 m / 13 ft
	Single rod Ø8 mm / 0.3"	4 m / 13 ft
	Coaxial Ø22 mm / 0.9"	6 m / 20 ft
	Double cable Ø4 mm / 0.15"	35 m / 115 ft
	Single cable Ø4 mm / 0.15"	35 m / 115 ft
	Single cable Ø8 mm / 0.3"	35 m / 115 ft

**Output**

Output signal	Output 1	4 ... 20 mA HART® or 3.8 ... 20.5 mA acc. to NAMUR NE 43
	Output 2 (option)	4 ... 20 mA (no HART® signal) or 3.8 ... 20.5 mA acc. to NAMUR NE 43
Accuracy		0.05% (rel. 20 mA; 20°C / 70°F)
Resolution		±2 µA
Temperature drift		Typically 50 ppm/K
Error signal		High: 22 mA; Low: 3.6 mA acc. to NAMUR NE 43
Max. Load		350 ohm

**Measuring accuracy**

Reference conditions acc. to IEC770	Temperature	+20°C ±5°C / +68°F ± 9°F
	Pressure	1013 mbar abs. ±20 mbar / 14.69 psig ±0.29 psig
	Relative air humidity	60% ±15%
Resolution		±1 mm / ±0.04"
Accuracy (in direct mode)	Liquids	±3 mm / 0.12", when L < 10 m / 33 ft; ±0.03% of measured distance, when L > 10 m / 33 ft
	Powders	±20 mm / ±0.8"
	Interface	±10 mm (εr constant)

**Application conditions**

Temperature	Ambient temperature	-40...+80°C / -40...+175°F; EExi: -40...+60°C / -40...+140°F
	Storage temperature	-40...+85°C / -40...+185°F
	Flange temperature	-40...+200°C / -40...+300°F (Ex: refer to relevant device's approval and temperature class)
Thermal shock resistance		100°C / min
Process conditions	Operating pressure	-1...40 bar / -14.5...580 psig; subject to process connection used and flange temperature
	Dielectric constant	≥1.4 for coaxial probe; ≥1.6 for single and double probes
Vibration resistance		IEC 68-2-6 and prEN 50178 (10...57Hz: 0.075 mm / 57...150 Hz: 1 g)
Protection category		IP 66/67 equiv. to NEMA 6-6X

**Mechanical data**

Material	Housing	Aluminium
	Single rod	Stainless steel (1.4404 / 316 L); Hastelloy C-22 (2.4602)
	Double rod	Stainless steel (1.4404 / 316 L); Hastelloy C-22 (2.4602)
	Coaxial	Stainless steel (1.4404 / 316 L); Hastelloy C-22 (2.4602)
	Single cable	Stainless steel (1.4401 / 316 ); Hastelloy C-22 (2.4602) (only cable Ø4 mm / 0.15")
	Double cable	Stainless steel (1.4401 / 316)
	Process fitting	Stainless steel (1.4404 / 316 L); Hastelloy C-22 (2.4602)
	Gaskets	Viton (-40...+150°C / -40...+300°F); Kalrez 6375 (-20...+150°C / -5 ...+300°F)
Process connection	Thread	G 3/4"...1 1/2"; NPT 3/4"...1 1/2"
	Flange	DN 25...DN 150 (PN 40 / PN 16); 1"...8" (150 lb / 300 lb); 10 K (40...100A)

**Electrical connection**

2-wire power supply	Terminals output 1	
	Non-Ex/ EEx i	24 V DC (14...30 V DC)
	EEx d	24 V DC (20...36 V DC)
	Terminals output 2	
Cable entry	Non-Ex/ EEx i/ EEx d	24 V DC (10...30 V DC)
		M20x1.5; NPT 1/2"; G 1/2"
Terminals		0.5...1.5 mm²

**Human machine interface**

Display	9 lines, 160x160 pixels in 8-step greyscale with 4-button keypad
Operating languages	English (UK), German, French, Italian, Spanish, Portuguese, Japanese, Chinese (Mandarin), Russian

**Approvals**

Overfill protection	WHG
ATEX	ATEX II G/D 1, 1/2, 2 EEx ia IIC T6; ATEX II G/D 1/2, 2 EEx d ia IIC T6
FM	IS class I Div. 1 Gr. A...G; XP class I Div. 1 Gr. A...G
CSA	IS class I Div. 1 Gr. A...G; XP class I Div. 1 Gr. A...G

## Dimensions

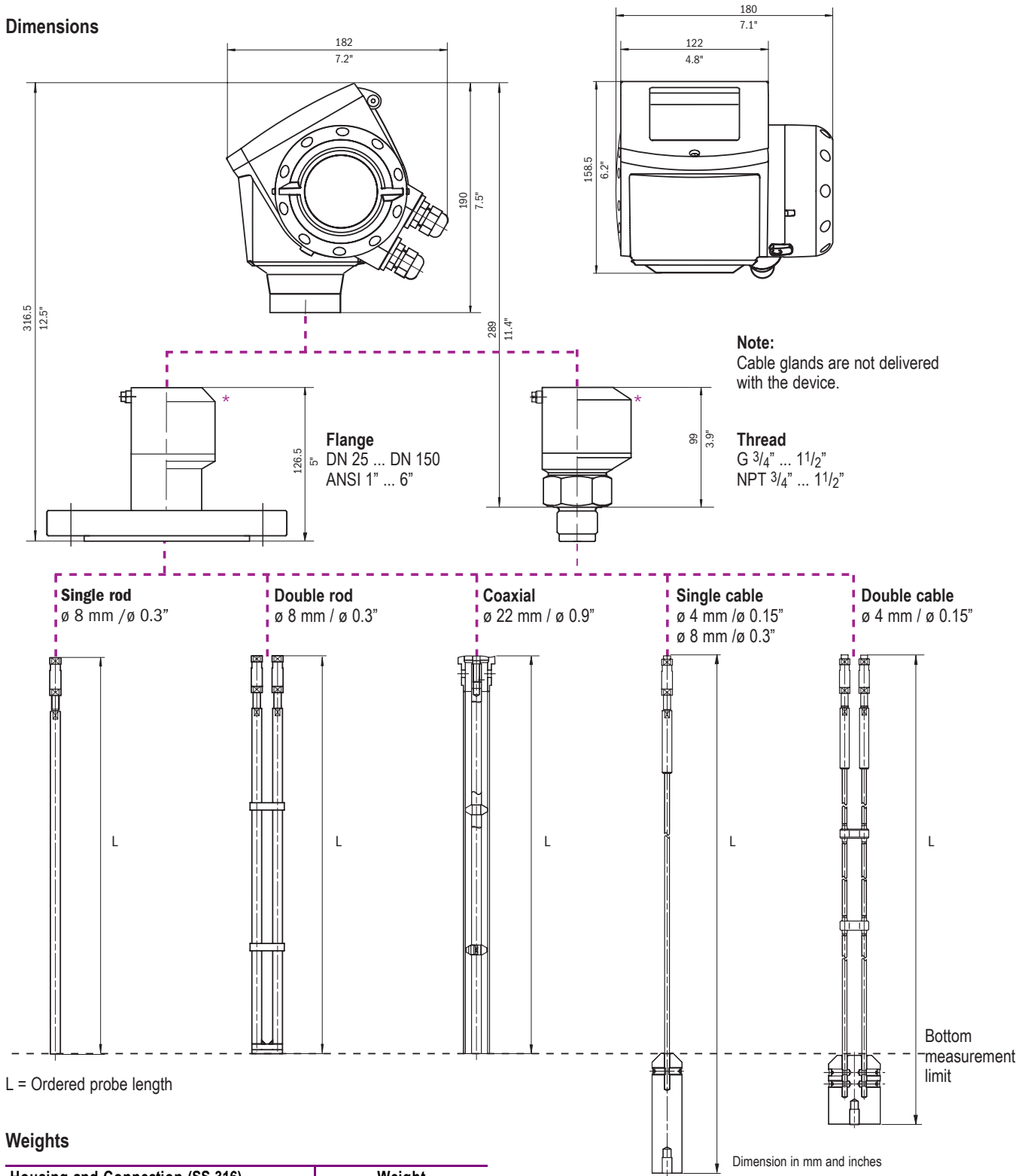

## Weights

Housing and Connection (SS 316)	Weight	
	[kg]	[lb]
Housing	3.3	7.3
Flange connection DN 25...80 / ANSI 1"...3"	4...7	8.8...15.4
Flange connection DN 100...150 / ANSI 4"...6"	7...12	15.4...26.5
Thread connection	3	6.6
Probes	[kg / m]	[lb / ft]
Single cable Ø4 mm / 0.15"	0.12	0.08
Single cable Ø8 mm / 0.3"	0.41	0.28
Double cable Ø4 mm / 0.15"	0.24	0.16
Single rod Ø8 mm / 0.3"	0.41	0.28
Double rod Ø8 mm / 0.3"	0.82	0.56
Coaxial Ø22 mm / 0.9"	0.79	0.53

**Note:**  
Wide range of counterweights and anchoring solutions available.  
Contact HYCONTROL for further information.

\* Only single cable ø 8 mm / ø 0.3"  
(solids application)

## Measurement limits

Probes	Top dead zone $\epsilon r = 80^*$ [mm / inch]	Bottom dead zone $\epsilon r = 80^*$ [mm / inch]	Top dead zone $\epsilon r = 2.3^*$ [mm / inch]	Bottom dead zone $\epsilon r = 2.3^*$ [mm / inch]
Double rod	125 / 4.9	10 / 0.4	165 / 6.5	50 / 1.95
Single rod	200 / 7.9	10 / 0.4	250 / 9.9	50 / 1.95
Coaxial	10 / 0.4	10 / 0.4	10 / 0.4	50 / 1.95
Double cable	125 / 4.9	10 / 0.4	165 / 6.5	50 / 1.95
Single cable $\varnothing 8 \text{ mm} / \varnothing 0.3''$	200 / 7.9	10 / 0.4	250 / 9.9	50 / 1.95
Single cable $\varnothing 4 \text{ mm} / \varnothing 0.15''$	200 / 7.9	10 / 0.4	250 / 9.9	50 / 1.95

\* 80 is  $\epsilon r$  of water; 2.3 is  $\epsilon r$  of oil

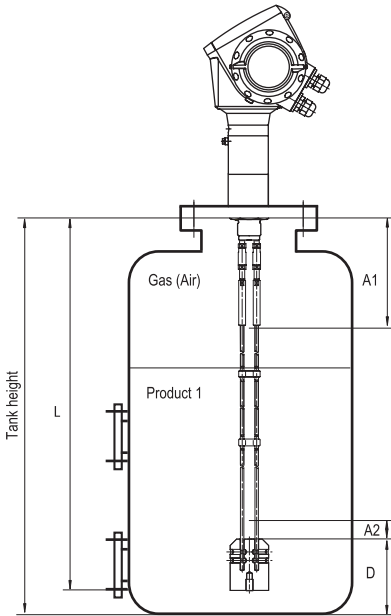

### A1, Top dead zone

Min. distance from flange to top limit of measuring range.

### A2, Bottom dead zone

Length at end of probe, where measurement is not possible.

### D, non measurement zone

Zone where measurement cannot be taken.

### L, Probe length

Length specified by customer in the order.

## Probe selection

	Double rod	Single rod	Coaxial	Double cable	Single cable $\varnothing 8 \text{ mm} / \varnothing 0.3''$	Single cable $\varnothing 4 \text{ mm} / \varnothing 0.15''$
<b>Maximum tank height</b>						
4 m / 13 ft	◆	◆				
6 m / 20 ft			◆			
35 m / 115 ft				◆	◆	◆
<b>Liquids</b>						
Liquid application	◆	◆	◆	◆	◆	◆
LPG, LNG	◆		◆	◆		
Highly viscous liquids		◆				◆
Highly crystallising liquids		◆				◆
Highly corrosive liquids	◆	◆	◆			◆
Foam		◆	◆			◆
Agitated liquids	◆		◆	◆*		◆*
Spray in tank			◆			
Storage tanks	◆	◆	◆	◆		◆
Installation in bypass chamber	◆	◆	◆	◆		◆
Small diameter nozzles	◆		◆	◆		
Long nozzles	◆		◆	◆		
Stilling wells	◆	◆	◆	◆		◆
Interface measurement	◆		◆	◆		

\* with anchor fitting

## Electrical connection

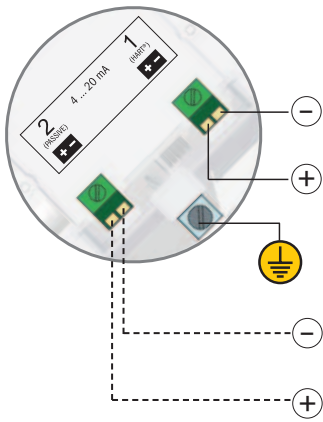

### Output 1

4 ... 20 mA/HART  
or  
3.8 ... 20.5 mA/HART  
acc. to NAMUR NE 43

### Output 2 (Option)

4 ... 20 mA  
or  
3.8 ... 20.5 mA  
acc. to NAMUR NE 43

## Non-Ex

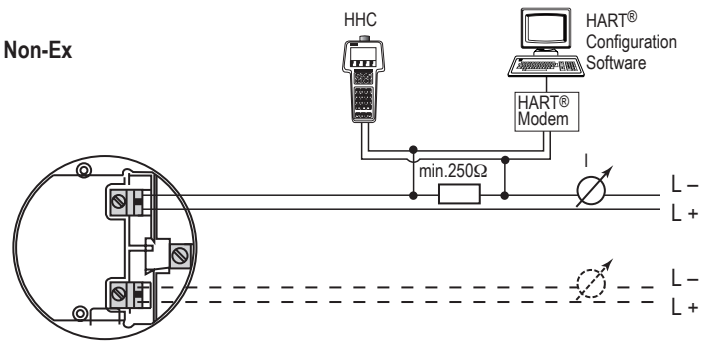

## Explosion Proof (XP) / Ex d

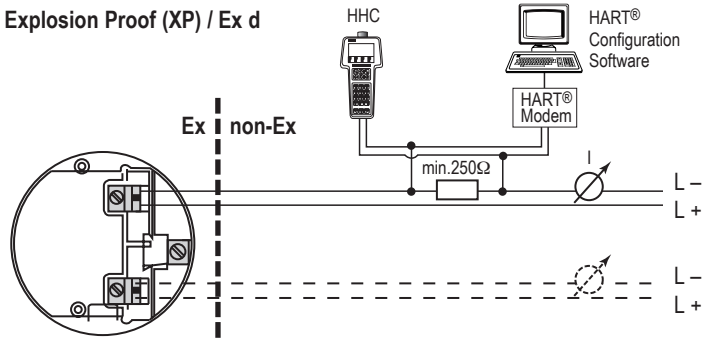

## Intrinsically Safe (IS) / Ex i

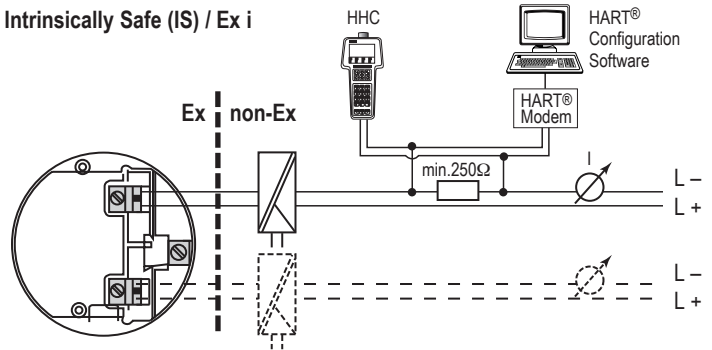

**Note:** Other options how to connect the HHC (Hand Held Communicator) and modem to the HART® loop are available.

## State-of-the-art with PACTware

The VF7 is PACTware-ready. Each device is supplied ex-factory with the appropriate DTM.

A DTM (Device Type Manager) is a device driver making available the device functionality independent from the FIELDBUS protocol and providing a graphical user interface optimized for device operation and configuration.

Simple on-screen and intuitive setup procedure for devices without a display, or for set up from the Central Control Room. Summarized setup provides perfect control of initial input, and a guarantees perfect results.

All features of PACTware are fully supported:

- Online device setup
- Displays measured values
- Records measured information during operation
- Shows status of device
- Gives stepwise setup with on-screen progress check
- Displays summary of setup selection for final supervision

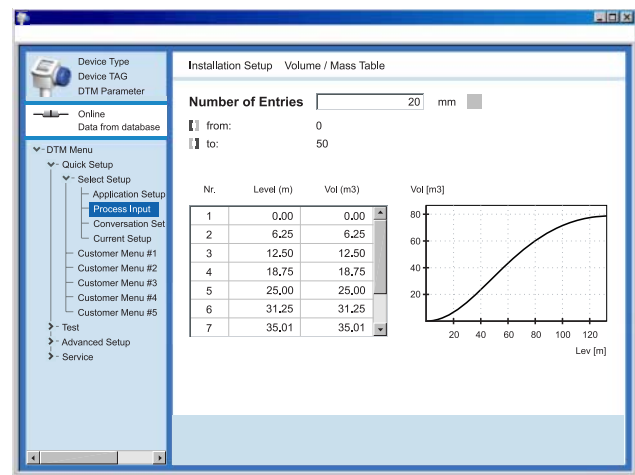
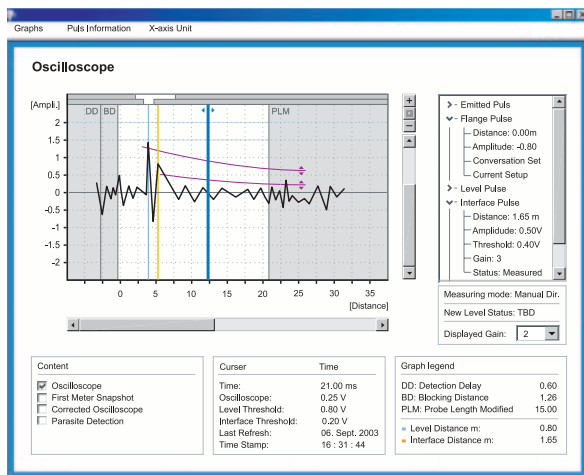

Hycontrol Ltd., Larchwood House, Orchard Street,  
Redditch, Worcestershire, B98 7DP.

Tel: 01527 406800 Fax: 01527 406810

Email: sales@hycontrol.com

Web: www.hycontrol.com